

Dialog 4220 Lite / Dialog 3210

BusinessPhone Communication Platform

User Guide



EN/LZTBS 160 1320 R1A
© Ericsson Enterprise AB 2003

Table of Contents

	page
Welcome	4
Description	6
Incoming Calls	14
Outgoing Calls	17
During Calls	28
Call Forwarding	37
Absence Information	44
Messages	51
Security	64
Group Features	67
Other Useful Features	73
Settings	82
Accessories	88
Useful Hints	91
Installation	92
Glossary	100
Index	103
Quick Reference Guide	107

Welcome

Welcome to the User Guide for the Dialog 4220 Lite / Dialog 3210 in the BusinessPhone Communication Platform from Ericsson. The BusinessPhone Communication Platform consists of BusinessPhone 50, BusinessPhone 128i, and BusinessPhone 250.

The features described in this User Guide are related to version 5.1 or higher of the BusinessPhone Communication Platform. Some might not work in earlier versions of the system and/or might be protected by a hardware dongle that has to be bought separately.

The User Guide describes the facilities of the BusinessPhone Communication Platform and the Dialog 4220 Lite / Dialog 3210 with a default programming. There may be some differences in the way your phone is programmed. Please consult your system administrator if you need further information.

The latest version of this User Guide can also be downloaded from: <http://www.ericsson.com/enterprise/>

Note: *Dialog 4220 Lite / Dialog 3210 is a system telephone, i.e. it can only be used for an Ericsson private branch exchange that supports this type of telephone.*

Copyright

All rights reserved. No parts of this publication may be reproduced, stored in retrieval systems, or transmitted in any form or by any means, electronic, mechanical, photocopying, recording or otherwise, without prior written permission of the publisher except in accordance with the following terms.

If this publication is made available on Ericsson media, Ericsson gives its consent to downloading and printing copies of the content provided in this file only for private use and not for redistribution. No parts of this publication may be subject to alteration, modification or commercial use. Ericsson will not be liable for any damages arising from use of an illegal modified or altered publication.

Warranty

ERICSSON MAKES NO WARRANTY OF ANY KIND WITH REGARD TO THIS MATERIAL, INCLUDING, BUT NOT LIMITED TO, THE IMPLIED WARRANTIES OF MERCHANTABILITY AND FITNESS FOR A PARTICULAR PURPOSE. Ericsson shall not be liable for errors contained herein nor for incidental or consequential damages in connection with the furnishing, performance or use of this material.

Declaration of Conformity

Hereby, Ericsson Enterprise AB, S-131 89 Stockholm, declares that this telephone is in conformity with the essential requirements and other relevant provisions of the R&TTE directive 1999/5/EC.

Details to be found at:

<http://www.ericsson.com/sdoc>

Description

Dialog 4220 Lite

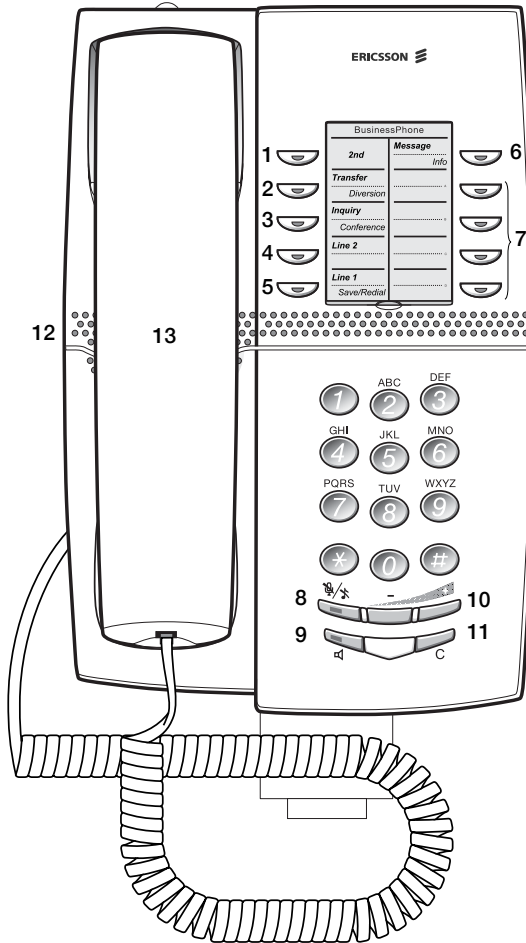

- 1 2nd**
Key for access to secondary key functions.
- 2 Transfer / Diversion**
 - a. Transfer an ongoing call. See section “[During Calls](#)” on page 28.
 - b. Activate/Deactivate diversion. See section “[Call Forwarding](#)” on page 37.
- 3 Inquiry / Conference**
 - a. To make an inquiry to an internal or external party.
 - b. To establish a telephone conference.
See section “[During Calls](#)” on page 28.
- 4 Line 2**
Line key 2 for in and outgoing calls.
- 5 Line 1 / Save/Redial**
 - a. Line key 1 for in and outgoing calls.
 - b. Save or redial an external number.
See section “[Outgoing Calls](#)” on page 17.
- 6 Message / Info**
 - a. To send and receive messages. See section “[Messages](#)” on page 51.
 - b. To enter information. See section “[Absence Information](#)” on page 44.
- 7 Programmable keys**
Storing numbers and program functions.
- 8 Mute**
To switch the microphone on or off. See sections “[During Calls](#)” on page 28 and “[Silent ringing](#)” on page 15.
- 9 Loudspeaker on/off**
To switch the loudspeaker on or off. See section “[During Calls](#)” on page 28.
- 10 Volume control**
To adjust the volume. See section “[Settings](#)” on page 82.
- 11 Clear**
To disconnect calls.
- 12 Loudspeaker**
- 13 Handset with hearing aid function**

Please note: *The handset may attract and retain small metal objects in the earcap region.*

Dialog 3210 Basic

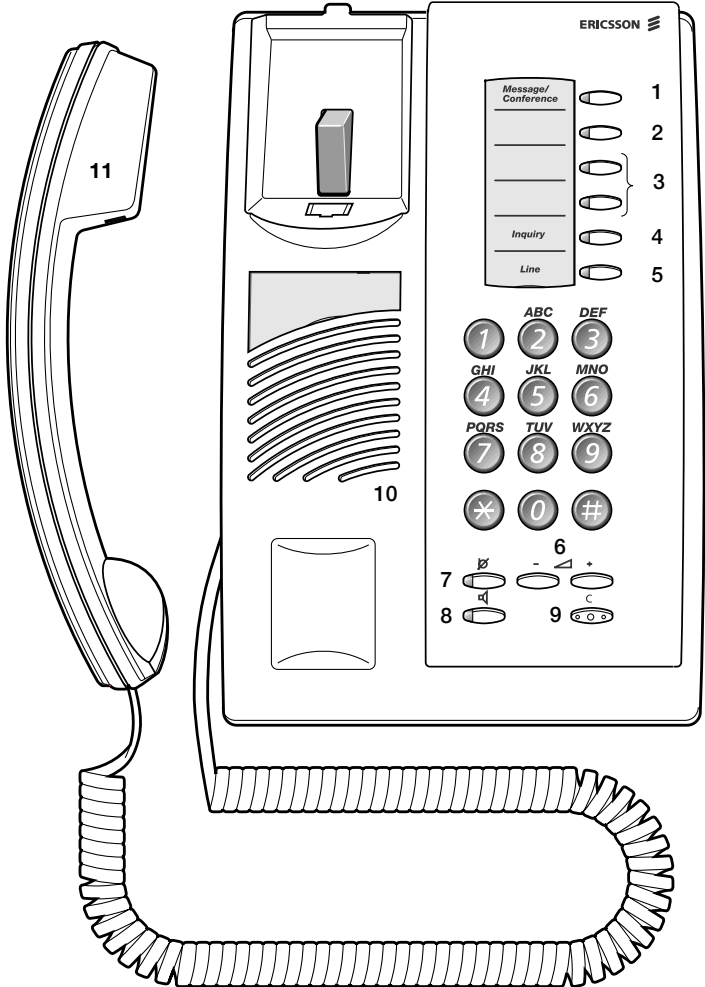

- 1 Message / Conference**
 - a. To send and receive messages. See section “[Messages](#)” on page 51.
 - b. To establish a telephone conference. See section “[During Calls](#)” on page 28.
- 2 Programmable key / Headset key**
 - a. Storing numbers and program functions.
 - b. The Headset function is only available with option unit (DBY 410 02) installed. The Headset key is programmed by the system administrator. See section “[Accessories](#)” on page 88.
- 3 Programmable keys**

Storing numbers and program functions. See section “[Settings](#)” on page 82.
- 4 Inquiry**

To make an inquiry to an internal or external party.
See section “[During Calls](#)” on page 28.
- 5 Line**

Line key for in and outgoing calls.
- 6 Volume control**

To adjust the volume. See section “[Settings](#)” on page 82.
- 7 Mute**

To switch the microphone on or off. See section “[During Calls](#)” on page 28.
- 8 Loudspeaker on/off**

To switch the loudspeaker on or off. See section “[During Calls](#)” on page 28.
- 9 Clear**











To disconnect calls.
- 10 Loudspeaker**
- 11 Handset with hearing aid function**

Please note: *The handset may attract and retain small metal objects in the earcap region.*

Phone keys Dialog 4220 / Dialog 3210





This table gives you an overview of the different key design of the Dialog 4220 Lite and the Dialog 3210 Basic. In this user guide you will only find illustrations of the Dialog 4220 keys.

If you are using the Dialog 3210 Basic, please refer to the table below to find out the appropriate key combination.

Key	Dialog 4220	Dialog 3210
Clear		
Headset	not available	Headset 
Loudspeaker		
Mute		
Programmable Function key		
Volume		

Lamp indications

The key lamps on your telephone indicate with different signals the traffic state of the ongoing call or function.

	Extinguished lamp	The function is not active.
	Steady light	The function is active.
	Slowly flashing lamp	The line (or function) is put on hold.
	Rapidly flashing lamp	An incoming call or message waiting.
	Light with short breaks	Ongoing call.

Tones

Tones are audible in the handset.

Dial tone

(System ready to accept digits)



Special dial tone

(System ready to accept digits, active diversion on telephone)



Ringing tone

(Ringing signal to called party)



- repeated after 4 s

Special ringing tone

(Ringing signal to Line 2)



- repeated after 4 s

Busy tone

(Called party is busy)



Number unobtainable tone

(Called number not accessible or vacant)



Call Waiting tone



Blocking tone

(Call cannot be executed due to congestion or called party blocked)



Verification tone

(Verification that ordered function is accessed)

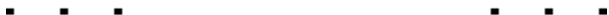

Intrusion tone

(Sent to all parties during Intrusion)



Signals

Ringing signals are emitted from the phone.

Internal ringing signal



- repeated after 4 s

External ringing signal

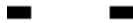

- repeated after 4 s

Automatic Callback signal



Note: *The tones and ringing signals in this guide refer to the standard system but may vary between countries.*

Incoming Calls

A ringing signal and a flashing lamp indicate an incoming internal or external call.



Answer calls

Lift the handset.

On another extension

You can answer a call to another extension from any phone in your office.



Lift the handset and call the ringing extension.

You receive busy tone.

6

Press.

Allow calls on Line 2

Note: *Dialog 4220 Lite only.*

If you also want to receive calls while speaking you first need to program Free On 2nd Access on a programmable key. See section “[Settings](#)” on page 82.

*Free On 2nd
Access*



Press to activate / deactivate Free On 2nd Access (pre-programmed).

When Free On 2nd Access is active the lamp lights and you can receive calls while speaking.

Answer a second call

Note: *Dialog 4220 Lite only.*

You are on the phone, when a muted ringing signal and a Line key flashes to indicate a new incoming call:

Line 2 

Press the flashing Line key.

The first call is put on hold.

To switch back to the first call:

Line 1 

Press the first Line key.

The second call is put on hold. You are connected to the first caller.



Press if you want to terminate the ongoing call.

A second call is waiting

A muted ringing signal will inform you, during a conversation, that a second call is waiting on your phone.

To answer the second call:



Press to finish the ongoing call.

The new call will be signalled on your phone.

Line 

Press to receive the new call.

Silent ringing

Note: *Dialog 4220 Lite only.*

This function is useful if you do not want to be disturbed by the ringing of the telephone. Incoming calls will only be indicated by the flashing Line key.

In idle mode:



Press to mute the ringer for incoming calls.

Save and redial incoming calls

When you receive an incoming external call, you can save the number in order to redial it easily (the number can contain 24 digits maximum). Previously saved number is erased.

Dialog 4220 Lite

Save number

Before you quit the call:

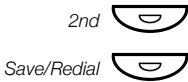

Press.

Press to save the dialled number.

Redial number

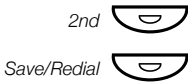

Press.

Press to redial the saved number.

Dialog 3210

Save number

Before you quit the call:



Press to save the dialled number (pre-programmed).

Redial number



Press to redial the saved number (pre-programmed).

Outgoing Calls

Sometimes you make a call but the person is not available. These functions will help you in your attempts to establish contact with the called party.

Make calls

How to make internal and external calls.



Lift the handset and dial either:



An extension number to make an internal call.

Or:



The digit(s) for external call access and the external number.

Note: Which digit to press for external call access, depends on the configuration of the system.

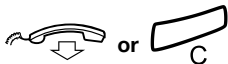

To end the call.

Note: You can make your calls faster, using Common Abbreviated Numbers and by programming your own Abbreviated Numbers, see section "[Abbreviated Numbers](#)" on page 23.

Last External Number Redial

When you initiate an external call the system automatically stores all the dialled digits, irrespective of whether the call was successful or not. See also section “[Automatic Redial](#)” on page 20.

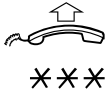

Lift the handset.

Press to redial the last dialled external number.

Save external number

When you make an external call, you can save the number in order to redial it easily. Previously saved number is erased.

Dialog 4220 Lite

Save number

Before you quit the call:



Press.

Press to save the dialled number.

Redial number



Press.

Press to redial the saved number.

Dialog 3210

Save number

Before you quit the call:



Press to save the dialled number (pre-programmed).

Redial number



Press to redial the saved number (pre-programmed).

Automatic Callback

You call an extension and receive busy tone or get no answer.

5

Press.

Verification tone.

Note: *The number for Automatic Callback may differ from country to country. See table “[Alternative programming for Automatic Callback, Camp-on, Intrusion](#)” on page 85.*

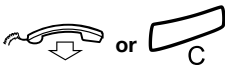

Replace the handset or press to finish the procedure.

You are called back if the extension finishes the ongoing call or the next time the extension finishes a new call. You have to answer within eight seconds otherwise the Callback service is cancelled.



Lift the handset when you are called back.

Automatic Redial

If you call an external number and receive busy tone or get no answer, you can instruct the system to automatically redial the number until it is available.

Note: *This feature could be restricted. Ask the system administrator for the availability.*

This function is activated via Function keys, so you first have to program a programmable key (one key required per number). See section “[Program a function](#)” on page 82. You can activate Automatic Redial on up to three external numbers at the same time.

Activate

During the call:

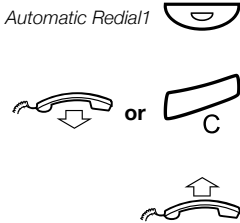

Press to activate (pre-programmed).

The Automatic Redial lamp is rapidly flashing and is lit when the request is stored and activated. Verification tone.

Replace the handset or press to finish the procedure.

You are called back if the called number finishes the ongoing call or the next time the extension finishes a new call.

Lift the handset when you are called back.

Notes: *It is not possible to do a new request on a key holding an already activated request until the existing one is cancelled.*

When the Automatic Redial lamp is rapidly flashing, your telephone is busy and you cannot receive or make new calls.

The number of redial attempts and how long the function is active is programmed by your system administrator.

If you have activated a diversion on your telephone, this function is not available.

If Tandem configuration is activated, the secondary telephone cannot use this function. See section “[Tandem configuration](#)” on page 73.

Automatic Redial1



Cancel

Press the relevant programmable key to cancel the Automatic Redial request (pre-programmed).

Note: Depending on system programming, the Automatic Redial request could be cancelled automatically.

Pause

It is possible to pause all of your successfully activated requests by programming a separate pause key, see section “[Program a function](#)” on page 82.

Pause Auto Redial



Press to pause (pre-programmed).

The requests are paused and the key lamps of the Automatic Redial keys are flashing slowly.

Pause Auto Redial



Press to resume Automatic Redial (pre-programmed).

Busy extension

You call an extension and receive busy tone.

Camp-on

You can notify a busy extension of your call by a muted ringing call.

4 Press to Camp-on.

Keep the handset off hook. When the called extension replaces the handset, it will be called automatically.

Note: *If you receive the busy tone again, the desired extension does not allow Camp-on.*

The number for Camp-on may differ from country to country, see table “Alternative programming for Automatic Callback, Camp-on, Intrusion” on page 85.

Intrusion

You can intrude on an ongoing call on a busy extension (if this function is allowed).

8 Press to intrude.

Intrusion tone is heard and a three-party call is established. When the called extension replaces the handset and you keep off hook, the called extension will be recalled automatically.

Note: *If you still hear the busy tone, your extension does not have the authority to intrude or the desired extension is protected against Intrusion.*

The number for Intrusion may differ from country to country, see table “Alternative programming for Automatic Callback, Camp-on, Intrusion” on page 85.

Diverted extension

Bypass Call Forwarding makes it possible to call a specific extension, even if Call Forwarding is activated on this extension.

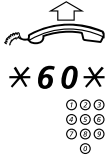

#

Lift the handset.

Dial.

Enter extension number.

Press.

You will be connected to the specified extension, regardless of which type of Call Forwarding the called extension has activated.

Abbreviated Numbers

By using Abbreviated Numbers, you can make calls simply by pressing a few keys. Frequently used external numbers are stored as Common Abbreviated Numbers in the exchange.

On the Dialog 4220 Lite, up to 14 Individual Abbreviated Numbers (your personal most frequently used external numbers) can be stored and used (Option 1 + 2).

On the Dialog 3210, you can use the number keys of the keypad for storing up to 10 Abbreviated Numbers (Option 2 only).

Option 1 - Via a programmable key

Only on the Dialog 4220 Lite, 4 Individual Abbreviated Numbers can be programmed on the programmable keys.

Note: *Functions that you activate/deactivate via a dial code, e.g. *32* and #32# for reminder, can also be stored as Individual Abbreviated Numbers.*

Option 2 - Via the keypad

10 Individual Abbreviated Numbers can be programmed on the keys 0 to 9.

Common Abbreviated Numbers

External numbers are stored centrally in your BusinessPhone Communication Platform. Common Abbreviated Numbers can be dialled from every extension that has the authority to do so.



Lift the handset.



Dial the Common Abbreviated Number.

Please refer to your telephone directory.

Individual Abbreviated Numbers via a programmable key

Note: *Dialog 4220 Lite only.*

You can program and activate your most frequently used external numbers on the 2nd layer of a programmable key. This procedure can also be used if you want to program a function that is activated/deactivated via a dial code.

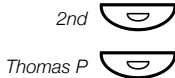

Press.

Press to make a call or activate a dial code (pre-programmed).

Program Individual Abbreviated Number

How to program external numbers or dial codes on a programmable key.

00

Enter Programming mode.

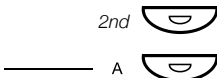

Press.

Press a programmable key.



Dial the digit(s) for external call access and dial the number.

Which digit to press for external call access, depends on the configuration of the system. The number can consist of up to 24 digits.

Note: If your public network requires waiting for a second dial tone, press the key 2nd followed by the key 2.

Or:



Dial a code (2 digits).

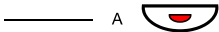

Press the programmable key again.



Press to finish programming.

Note: The Dual-Function keys allow Individual Abbreviated Numbers and other functions e.g. Dial-by-Name to be combined on the same keys. You can remove the transparent cover in order to write the names beside the keys. Put the name referring to the Individual Abbreviated Number in the field below the line to indicate that it is the secondary function.

Individual Abbreviated Numbers via the keypad

You can program and activate your most frequently used external numbers via the keypad.



Lift the handset.

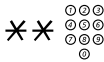

Press and dial the Abbreviated Number.

A number between 0 and 9.

Program Individual Abbreviated Number

How to program external numbers on the keys 0 to 9.

*** 5 1 ***

Enter Programming mode.



Select an Abbreviated Number between 0 and 9 and press.



Dial the digit(s) for external call access and dial the number.

The number can consist of up to 24 digits.

*Note: If your public network requires waiting for a second dial tone, press *.*

#

Press.



Press to finish programming.

Cancel one specific Individual Abbreviated Number

5 1 *

Press.



Enter an Abbreviated Number between 0 and 9 and press.

Cancel all Individual Abbreviated Numbers

5 1

Press.

Confirmation tone.

Dial-by-Name

You can program and activate directory numbers (extensions and Common Abbreviated Numbers) on the programmable keys. If you have programmed a number on a programmable key, you just have to press this key to call the desired person.



Michael P.



Lift the handset.

Press to make a call (pre-programmed).

Program Dial-by-Name

How to program an internal directory number on a programmable key.

*** 0 0 ***

Enter Programming mode.



Press a programmable key.

1 0

Press.



Press the programmable key again.



Dial the number.

You can use any directory number, e.g. a Common Abbreviated Number or a colleague's extension number.



Press the programmable key again.



Press to finish the procedure.

During Calls

The BusinessPhone Communication Platform allows you to handle calls in many different ways. You can monitor calls, mute the microphones, make an inquiry, transfer the call, create a conference or put the call on hold to perform other tasks.

Group Listening

Note: *Dialog 4220 Lite only.*

You have an ongoing conversation via the handset.



Press to switch the loudspeaker on or off.

When the lamp lights, the loudspeaker monitors the call.

Note: *You can adjust the volume, see section "[Settings](#)" on page 82.*

Monitoring

Note: *Dialog 3210 only.*



You have an ongoing conversation via the handset.

Press to switch the loudspeaker on.

When the lamp lights, the loudspeaker monitors the call.

Note: *When the loudspeaker is on, the microphone is automatically switched off in the handset.*



From monitoring to handset

Press to switch the loudspeaker off.

Continue your conversation via the handset.

Mute



You have an ongoing conversation.

Press to switch the microphone on or off.

When the lamp lights, the caller will not be able to hear the conversation in your room.

Inquiry

During an ongoing conversation you wish to make an inquiry to an internal or external party.

Dialog 4220 Lite

Inquiry 

Press.

Or:

Line 2 

Press Line 2.

The first call is put on hold (the lamp flashes slowly).



Call the third party.

When the third party answers you can switch between the calls, create a Conference and end one of the calls.



Press to end the Inquiry call.

The second call is disconnected.

Line 1 

Press to retake the first call.

You are now connected to the first party.

Dialog 3210

Inquiry 

Press.

The first call is put on hold (the lamp flashes slowly).



Call the third party.

When the third party answers you can switch between the calls, create a conference and end one of the calls.



Press to end the Inquiry call.

The second call is disconnected.

Line 

Press to retake the first call.

You are now connected to the first party.

Refer Back

You have an ongoing conversation and want to refer back to the call that is put on hold. The lamp of the call put on hold flashes.

Dialog 4220 Lite

You have an ongoing conversation on e.g. Line 2 and want to refer back to the call that is put on hold on Line 1. The lamp of the call put on hold flashes.

Line 1 

Press to put the second call on hold.

First call is connected.

**Inquiry or
Line 2**



Press to put the first call on hold.

Second call is connected.



Press to end the ongoing call.

Dialog 3210

Line 

Press to put the second call on hold.

First call is connected.

Inquiry 

Press to put the first call on hold.

Second call is connected.



Press to end the ongoing call.

Transfer

You have an ongoing internal or external conversation and you want to transfer the ongoing call.

Dialog 4220 Lite

Inquiry 



Press.

Call the third party.

You can transfer the call before answer or wait for answer.

Note: *Make sure, that you are connected to the desired party. Please read the notes and warnings in section “Useful Hints” on page 91.*

Transfer 



Press.

Or:

Replace the handset.

The call is transferred. External calls might only be transferred with the Transfer key, if this state of connection is allowed by the System programming.

Dialog 3210

Inquiry 



Press.

Call the third party.

You can transfer the call before answer or wait for answer.

Note: *Make sure, that you are connected to the desired party. Please read the notes and warnings in section “Useful Hints” on page 91.*



Replace the handset.

The call is transferred. External calls might only be transferred with the Transfer key, if this state of connection is allowed by the system-programming.

Transfer to a busy extension

You can even transfer calls to busy extensions. The other party will hear a muted signal (Camp-on), and the call will be extended, as soon as the ongoing call is terminated (if Camp-on is allowed).

Callback

You are called back, if you have transferred an external call and the other extension has not answered the call within a certain time. Your telephone will ring again.

Call Waiting

If you hear the Call Waiting tone during an ongoing conversation, another person is trying to contact you.

To terminate the ongoing call and answer the waiting call



Replace the handset to finish the ongoing call.

The waiting call is signalled on your phone.



Lift the handset to answer the new call.

Conference

You have an ongoing conversation and you want to establish a telephone Conference.

Dialog 4220 Lite

Inquiry 

Press.

Or:

Line 2 

Press.



Call the third party.

2nd 

Press.

Conference 

Press to establish a three party Conference.

Now you have established a three party conference. To indicate the Conference, all Conference members will hear a periodical Conference tone.

Repeat the procedure to include other persons into the Conference.

In this way, you can include up to six parties in a conversation. How many of them can be external callers depends on the programming of the system.

Dialog 3210

Inquiry 

Press.

Message 

Call the third party.

Press to establish a three party Conference (pre-programmed).

Now you have established a three party Conference. To indicate the Conference, all Conference members will hear a periodical Conference tone.

Repeat the procedure to include other persons into the Conference.

In this way, you can include up to six parties in a conversation. How many of them can be external callers depends on the programming of the system.

Individual Hold

You have an ongoing conversation, i.e. the Line key is lit. Now you want to put the ongoing call on hold for a short while.

Line 

Press the Line key.

The lamp flashes slowly.

Line 

Press again to retake the call that has been put on hold.

Note: *This is also valid for the Inquiry key.*

Common Hold

Hold 

Press (pre-programmed).

The Line key lamp flashes slowly. The call can be picked up on any extension within one minute, or if not it will recall on the holding extension.

Line 

Press to pick-up on own extension.

Or:

Pick-up on another extension:



Call the extension that put the call on hold.

6

Press.

Call Forwarding

When you are not available to take calls or decide to answer your calls on another extension, it is useful to forward your calls to an alternate answering position.

If you urgently need to talk to someone who has forwarded his calls, the system is also equipped with a bypass function.

Depending on the type of diversion you are also able to record your Personal Greeting, see section “[Personal Greeting](#)” on page 53.

Note: *You can still make calls as usual.*

Diversion when there is no answer

If you are not available to answer incoming calls (internal or external), your system administrator can program your extension to automatically divert calls to a programmed diversion address (default time: 15 seconds).

Diversion when caller receives busy tone

If your extension is busy and you receive an incoming call (internal or external), your system administrator can program your extension to automatically divert the call to a programmed diversion address.

Fixed Diversion

This function directs your calls to a pre-programmed answering position (e.g. secretary).

Dialog 4220 Lite

Activate Fixed Diversion

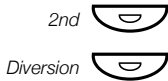

Press.

Press to activate diversion.

All calls to your extension are directed to a pre-programmed address.

Cancel diversion



Press.

Press to cancel diversion.

Dialog 3210

Activate Fixed Diversion

*** 2 1 #**



Dial to activate diversion.

Press.

All calls to your extension are directed to a pre-programmed address.

Cancel diversion

2 1



Dial to deactivate Fixed Diversion.

Press.

Program Fixed Diversion address

Note: *Dialog 4220 Lite only.*

If you need to program a new diversion address:

00

Dial to start programming.

2nd 

Press.

Diversion 

Press.



Dial new diversion address.

2nd 

Press.

Diversion 

Press.



Press to finish the procedure.

Individual Diversion

This feature gives you the possibility to divert your calls to internal and external positions, e.g. to any directory number, a colleague's extension, an external number or a Common Abbreviated Number (e.g. your car telephone).

Note: In order to prevent misuse, the Individual External Diversion can be blocked for your extension, see section "Security" on page 64.

Dialog 4220 Lite

Program and activate Internal Diversion

Divert your calls to an internal position.



Press.



Press and dial the new directory number.

Any directory number.



Press.

Press.

Verification tone. The Diversion lamp lights and remains lit. The display shows the actual Follow-me state.



Press to finish the procedure.

You can make outgoing calls as usual. A special dial tone reminds you that Call Forwarding is active.

Note: An Individual Internal Diversion cannot be activated if an Individual External Diversion is already activated.

Cancel Internal Diversion



Press.

Press.

Individual Diversion is cancelled. The lamp extinguishes.

Dialog 3210**Program and activate Internal Diversion**

Divert your calls to an internal position.

*** 2 1 ***

Dial.



Enter the new diversion address.

#

Press to activate the Individual Diversion.

Verification tone.



Press to finish the procedure.

You can make outgoing calls as usual. A special dial tone reminds you that Call Forwarding is active.

Note: *An Individual Internal Diversion cannot be activated if an Individual External Diversion is already activated.*

Cancel Internal Diversion

2 1

Dial.



Press.

Program and activate a new External Diversion address

To set a new Individual External Diversion address:

*** 2 2 ***

Dial.

0 

Dial the digit(s) for external call access and enter the new External Diversion address.

A maximum of 24 digits.

***Note:** If your public network requires waiting for a second dial tone, press *.*

#

Press to activate the Individual Diversion.

Verification tone.



Press to finish the procedure.

***Notes:** Before you leave, call your extension to check if the External Diversion has been set up correctly. This way you can make sure that the number has been programmed properly and that your calls will not be diverted to another person by mistake.*

Individual External Diversion can also be used via the DISA function, see section “Other Useful Features” on page 73.

Cancel External Diversion

2 2

Dial.



Press.

***Note:** The programmed diversion address is not removed from the memory, the diversion is just inactive.*

Re-activate External Diversion

Divert your calls to an external position.

*** 2 2 * #**

Dial to activate the programmed External Diversion.

You can make outgoing calls as usual. A special dial tone reminds you that Call Forwarding is active.



Press.

Follow-me

If you are in another room, you can still answer your calls by forwarding them to where you are. To activate Follow-me, Individual Diversion must be active on your telephone.

Activate Follow-me

Note: This procedure has to be executed from the telephone the calls are diverted to.

*** 2 1 ***

Dial.



Dial your number and press.



Dial the new number and press.
Special dial tone.



Press to finish the procedure.

Cancel Follow-me

Follow-me and Individual Diversion can also be cancelled from the answering position.

2 1 *

Dial.



Dial your number.



Press.
Dial tone.



Press to finish the procedure.

Absence Information

If you are not in the office for a certain period of time (e.g. meeting, vacation, lunch, illness), this feature allows you to inform your callers of the reason of your absence. External callers will be routed to the operator who also has access to your absence info.

Note: *When you have activated a diversion with a Personal Greeting, callers will receive this greeting even if you have activated the Absence Information, see section “[Personal Greeting](#)” on page 53.*

You can inform your callers with:

1) Pre-defined texts

Enter the reason for your absence and the date and time of your return.

2) Voice information

Record a Voice message and name the reason of your absence.

Enter information - Dialog 4220 Lite

To store Text or Voice information.



Press.



Press.

When the information is activated, the Message/Info lamp shows a steady light. If a message arrives, the lamp starts flashing.

Select Pre-defined Text or Voice information.

Pre-defined texts



Enter Info Code and Completing Info (see table).

	Code	Completing Info
Time of return	1	hour (00-23) minute (00-59)
Date of return	2	month (01-12) day (01-31)
Lunch	3	back at, hour minute
Meeting	4	back at, hour minute
Vacation	5	back, month day
Illness	6	back, month day

#

Press to enter the information.



Press to finish the procedure.

The programmed absence info will be shown in the display. Internal callers receive the information on the display (or as spoken information to callers without display phone). External callers will be routed to the operator who also has access to your absence info.

Pre-defined texts example: Vacation, back June 27



Press.



Press.

5

Enter code.

0 6 2 7

Enter month and day.

#

Press.

Information active.

Voice information



Press.



Press.

9

Press and speak.

Press to play-back and listen to your recording.

9

Press and speak to re-record.

#

Press to activate.



Press to finish the procedure.

Internal callers will hear the information via the handset or the loudspeaker. External callers will be routed to the operator who also has access to your absent info.

Note: You can dial your own extension number if you want to check your information.

Change information

Note: *Dialog 4220 Lite only.*

Erase information



Press.



Press.

0 #

Press to erase info.

Save information



Press.



Press to deactivate and save for later use.
Information is passive.



Press to finish the procedure.

Use saved information

When the information is switched off:



Press.



Press to activate saved info.

The Message/Info lamp lights. Information is active.



Press to finish the procedure.

Enter information - Dialog 3210

To store Text or Voice information.

*** 2 3 ***

Dial to enter the information mode.

Select Pre-defined Text or Voice information.

Pre-defined texts



Enter Code.



Enter Completing Info from the table below.

	Code	Completing Info
Time of return	1	hour (00-23) minute (00-59)
Date of return	2	month (01-12) day (01-31)
Lunch	3	back at, hour minute
Meeting	4	back at, hour minute
Vacation	5	back, month day
Illness	6	back, month day

#

Press to enter the information.



Press to finish the procedure.

Internal callers receive the information on the display (or as spoken information to callers without display phone). External callers will be routed to the operator who also has access to your absence info.

Pre-defined texts example: Vacation, back June 27

*** 2 3 ***

Press.

5

Enter code.

0 6 2 7

Enter month and day.

#

Press.

Information active.

Voice information

*** 2 3 ***

Press to enter information mode.

9

Press and speak.

Press to play-back and listen to your recording.

9

Press and speak to re-record.

#

Press to activate.



Press to finish the procedure.

Internal callers will hear the information via the handset or the loudspeaker. External callers will be routed to the operator who also has access to your absent info.

Note: *You can dial your own extension number if you want to check your information.*

Change information

Note: Dialog 3210 only.

Erase

2 3



Press to erase info.

Press to finish the procedure.

Save

* 2 3 * #



Press to deactivate and save for later use.
Information is passive.

Press to finish the procedure.

Use saved information

When the information is switched off:

* 2 3 * #



Press to activate saved info.
Information is active.

Press to finish the procedure.

Messages

By using the Message system you can send, receive, forward and store different kind of messages. You have also access to a number of helpful features, like recording an ongoing conversation, placing external calls via the company network and many more ...

Password protection

The first time you enter the Message system (only possible from your own extension) you might be requested to change your Password if it is default (0000).

Note: *Some systems are programmed to allow the Default Password.*

Follow the voice announcements.

You are requested to enter a new Password, confirm and save it. If you use the Default Password, you are requested to try again.



Press to finish the procedure.

Or:

Continue with any of the Message functions.

If you want to change your Password again, it is possible from the Message system or via the function "[Change Password](#)" on page 64.

Individual Mailbox system

Callers are able to leave messages in your Individual Mailbox.

Dialog 4220 Lite

Activate

Divert your extension to the Mailbox system.

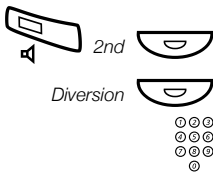

Press.

Press.

Dial the number to the Mailbox system.

Ask the system administrator for your defined Mailbox system number.

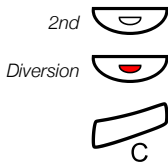

Press.

Press.

Press to finish the procedure.

When the diversion to your Mailbox is activated, the Diversion lamp shows steady light.

Deactivate



Press.

Press.

Dialog 3210**Activate**

Divert your extension to the Mailbox system.

*** 2 1 *****Dial.****Dial the number to the Mailbox system.**

Please ask the system administrator for your defined Mailbox system number.

**Press.****Press to finish the procedure.****Deactivate****# 2 1 #****Dial.****Press to finish the procedure.****Personal Greeting**

Depending on the type of diversion you want to activate, you can leave three different Personal Greetings to the caller. You can activate a diversion when a caller receives busy tone, when there is no answer, or you can activate the Individual Diversion for all your calls.

**Lift the handset.***** 5 9 #****Dial.**

During the procedure you will be asked for your extension number and your Password.

2



Press to configure your Personal Greeting.

Enter diversion code.

Select an option below and follow the voice announcements.

Type of diversion	Code
Diversion greeting on busy	1
Diversion greeting on no reply	2
Individual Diversion greeting	3

#



Press to store the recorded greeting.

When you activate the diversion, the recorded greeting is played to the next caller.

Press to finish the procedure.

Note: When you have activated a diversion with a Personal Greeting, callers will receive this greeting even if you have activated the Absence Information, see section [“Absence Information”](#) on page 44.

Retrieve messages - internally

When a new message is received, the Message lamp flashes rapidly.



Lift the handset.



Press to retrieve a message.

See section [“Check and store received messages”](#) on page 56.

Retrieve messages - externally

To retrieve your messages from an external position:



Dial your company's telephone number.



Dial the number to the Mailbox system.

During the procedure you will be asked for your extension number and your Password.

Note: You cannot use the Default Password 0000 to retrieve messages externally. If you want to check your messages from an external position, you have to change your Password first, see section [“Change Password”](#) on page 64.

The following Mailbox functions can also be used from an external position:

- Change Password
- Check and store received messages
- Forward a Voice message
- Send Message
- Outcall (External) notification
- Personal Greeting

Outcall (External) Notification

With this function the Message system can notify you when new Voice messages arrive. You can specify an external number, where you will be called at a pre-programmed time or as soon as a new message arrives.

Note: *This feature may be restricted or not available. Ask the system administrator for the availability and for more information.*

You can be notified in two different ways (depending on the programming of the system):

Notification with Mailbox access:

You acknowledge the notification via your Password (has to differ from the default value 0000). See section “[Change Password](#)” on page 64 to select a new Password. You have full access to the Mailbox system.

Notification without Mailbox access:

You get a short voice announcement, informing that someone has left a message for you. You acknowledge the notification by pressing any key. You have to call back the Mailbox system to retrieve the message.

Note: *If you do not acknowledge the notification within the pre-programmed time, the connection is cancelled and repeated later (ask the system administrator for the programmed number of notification attempts).*



Programming

Press to view the Mailbox.

Note: Depending on the configuration, you might be asked for your Password.

Follow the voice announcements.

You can program the external notification number, the notification time and activate/deactivate the function. The external number (including the digit(s) for external call access) can consist of up to 24 digits. The time is entered in 24h format, e.g. 2030 for half past eight with values automatically set to even quarters, i.e. 2013 will be 2015.

Note: The notification number and time must be programmed before you activate the notification.



Press to finish programming.

Check and store received messages

You can check and store your received messages.

Received messages are divided into the following three categories:

- New messages (not heard)
- Heard messages
- Stored messages

Voice messages can also be forwarded to other Mailbox numbers (Individual or Common), see section "[Forward a Voice message](#)" on page 57.

Note: Messages are deleted from the system after a certain time. The time depends upon the category of the message. Please ask your system administrator regarding this.



Press to view the Mailbox.

If the Mailbox contains heard messages only, the lamp shows steady light instead. You can check and store your received messages. Up to 20 messages can be stored.

Voice messages will be heard via the speaker or the handset. Call Me messages will call the sender automatically (these messages cannot be stored).

Note: Depending on the configuration, you might be asked for your Password before you can retrieve your messages. See section "[Security](#)" on page 64.



Press to finish the procedure.

Forward a Voice message

Your received Voice messages (in the Individual or Common Mailbox) can be forwarded to other Mailbox numbers (Individual or Common). When you forward a Voice message to an Individual Mailbox, the Mailbox number is the same as the extension number.



Press to view the Mailbox.

Note: *Depending on the configuration, you might be asked for your Password before you can retrieve your messages. See section "[Security](#)" on page 64.*

Follow the voice announcements.

You can forward new, heard or stored Voice messages.

Note: *The forwarded message is a copy, i.e. it can be deleted without deleting the original message.*

Repeat the procedure to forward the message to another Mailbox.



Press to finish the procedure.

Common Mailbox system

If you divert your telephone to a Common Mailbox, the callers are able to leave messages there. The difference between your Individual Mailbox and a common one is that a Common Mailbox can be used by more than one user.

Dialog 4220 Lite

Activate

Divert your extension to the Mailbox system.

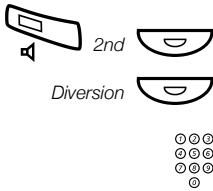

Press.

Press.

Dial the Common Mailbox number.

Please ask the system administrator for your defined Mailbox number.

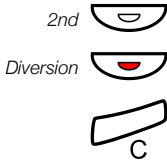

Press.

Press.

Press to finish the procedure.

When the diversion to your Mailbox is activated, the Diversion lamp shows steady light.

Deactivate



Press.

Press.

Dialog 3210**Activate**

Divert your extension to the Mailbox system.

*** 2 1 *****Dial.****Dial the Common Mailbox number.**

Please ask the system administrator for your defined Mailbox number.

#**Press.****Press to finish the procedure.****Deactivate****# 2 1 #****Dial.****Press to finish the procedure.****Retrieve messages - internally****Lift the handset.**

Common Mailbox

**Press the Common Mailbox key (pre-programmed).**

During the procedure you will be asked for your extension number and your Password. See section "[Security](#)" on page 64.

Retrieve messages - externally

To retrieve your messages from an external position:



Dial your company's telephone number.



Dial the Common Mailbox number.

During the procedure you will be asked for your extension number and your Password.

Note: *You cannot use the Default Password 0000 to retrieve messages externally. If you want to check your messages from an external position, you have to change your Password first, see section “[Change Password](#)” on page 64.*

Send Message

To send a message to an extension when you receive busy tone or get no answer.

Callback message

To send a Call Me message.

Message 

#

Press.

Press to send.

Voice message

Message 

9

Press.

Press and speak a Voice message.

Press to play-back and listen to your recording.

9

Press and speak to re-record.

#

Press to send.

Dictaphone function

If you want to record and retrieve personal Voice messages you can use the Dictaphone function. A Dictaphone message is treated as a normal message. How to retrieve Dictaphone messages, see section "[Check and store received messages](#)" on page 56.

Record message

To start the recording:

*** 5 8 #**

Dial and record your message.

The maximum recording time is 4 minutes and 15 seconds.

Select one of the following options:

Press to play-back.

9

Press and speak to re-record.

#

Press to stop the recording and save the message.

Conversation Recording

The Conversation Recording function makes it possible to store the ongoing telephone conversation in the Individual Mailbox by pressing a pre-programmed Recording key. You can store both internal and external calls. Conference calls cannot be stored.

A recorded conversation is treated as a normal Voice message. How to retrieve Conversation Recordings, see section “[Check and store received messages](#)” on page 56.

Note: *This feature may be restricted or not available. Ask the system administrator for the availability and for more information. Furthermore, a Conference tone can be audible during the entire recording session.*

To start or stop recording the ongoing call:

Recording 

Press the Recording key (pre-programmed).

While recording is active a steady light indicates that the conversation is being recorded. You can start or stop the recording whenever you want. The maximum recording time is 4 minutes and 15 seconds, if you want to record for a longer period, just repeat the procedure.

Warning! *Recording a conversation without prior notice to the other party may be illegal. Forwarding or playback of this recorded conversation to a third party without prior permission may be illegal.*

It is obligatory for the recording initiator, to ask the other party in advance for permission and to inform the same of the purpose and further usage of this particular recording. The adherence to the relevant legislation is the exclusive responsibility of the user, offences can be criminally prosecuted. Neither the manufacturer nor the dealer of this product is responsible for the abuse of this feature by the user or for any damages caused thereby.

Security

You can use your four-digit Password for blocking your phone from unauthorized use, for making external calls from any blocked extension, for entering the Message system or when you are using the DISA function.

Note: *The first time you enter the Message system you might be requested to change your Password if it is default (0000). This procedure is performed directly in the Message system. See section “[Messages](#)” on page 51.*

Change Password

* 7 2 *

Dial to select a new Password.



Dial your present Password.
The Default Password is 0000.



Press.



Dial your new Password.



Press.
Verification tone.



Press to finish the procedure.

Bypass blocked extension

In order to make a call, you can temporarily bypass a blocked extension.



Bypass own extension

Lift the handset.

72

Dial.



Dial your Password.

#

Press.

Dial tone. You can make one call from your extension.

Bypass another extension

This makes it possible to make a call on another, blocked extension, by using your Password.



Lift the handset.

72

Dial.



Dial your Password.

Press.



Dial your extension number.

#

Press.

Dial tone. You can make one call from the blocked extension.

Block extension

***72#**



Dial to block your extension.
Verification tone.

Press to finish the procedure.

Un-block extension

#72*



Dial.

Dial your Password.

#



Press to re-open.

Verification tone. Your extension is open for use.

Press to finish the procedure.

Group Features

When you are working together in a team the following Group features can be very useful. You can page your colleagues, give them telephone attendance or pick-up their incoming calls.

Key system

With this function, all (or selected) external lines are represented by pre-programmed keys on all phones. For each external line, a Function key has to be programmed. Which means that you are able to monitor the state of traffic for every programmed external line (e.g. free, busy). You can also establish an external call by pressing the External Line key.

Answer an external call

To answer an external call, just press the flashing key. (Depending on the programming of the system, an incoming external call will be announced with a flashing Line key and a ringing signal.)



Lift the handset.

External Line 

Press (pre-programmed).

Speech connection with the caller.

Make an external call

To initiate an external call, just press the External Line key.
The external line will be seized automatically.



Lift the handset.

External Line

Press a free Line key (pre-programmed).



Dial the desired number.

If you make external calls in this way, you do not have to dial the digit(s) for external call access first.

Supervision/Telephone Attendance

A Function key can also be programmed for Supervision and handling calls for a group of extensions. If a Supervision/Attendance key is programmed on your telephone, you are able to call the other group members or answer incoming calls for the group by pressing the key and monitor the activity of other extensions (free, busy, called).

Traffic situation

Michael

Ongoing conversation (lamp is on).

Michael

Free extension (lamp is off).

Michael

The extension is called (flashing lamp).

Pick-up calls for the group

Your colleague's extension is indicated on your phone by a pre-programmed key.



Lift the handset.

Michael

Press to answer the calls directly (pre-programmed).

A flashing lamp beside the key indicates an incoming call.



Call a group-member

Lift the handset.

Michael



Press to make a call (pre-programmed).

Note: If the key is flashing, you will automatically pick-up your colleague's ongoing call.

Group Call-pick-up

In a Pick-up group, any member can answer any individual call to group members. You answer a call to the group by dialling a special answering number. Please ask your system administrator for the configured number.



Lift the handset.



Dial the Group Call-pick-up code.

Loudspeaker Paging

You can page all extensions in a group and give a Voice message.



Lift the handset.

Paging



Press (pre-programmed).

All extensions in a group are called.

Paging



Press again and hold the key (pre-programmed).

Give the Voice message and then release the key. Now you can wait for answer, or terminate. If you do not get an answer within 30 seconds, the Paging function will be terminated automatically.

Answer Paging

A short signal and a flashing Paging key will inform you when a Loudspeaker Paging is received.



Lift the handset.



Press (pre-programmed).

An internal call is established with the paging party.

Common Bell

The Common Bell facility allows all extensions of the system (operator included) to pick-up the call from an extension that has been predefined as a Common Bell extension.



Dial the Common Bell pick-up code.

Please ask your system administrator for the Common Bell pick-up code.



Lift the handset.

You will immediately be connected to the calling party.

If two or more extensions simultaneously attempt to answer a call from the Common Bell extension, only the first extension will pick it up. The other extensions will receive the number unobtainable tone. This will also happen if you dial the Common Bell pick-up code and there are no calls waiting at the Common Bell extension.

Note: *You can also program the Common Bell code on a Function key.*

Group Hunting

Your telephone can be included in one or several hunt groups. In a hunt group all members are represented with one common directory number. 16 hunt groups can be programmed, each containing 1 to 20 members. A member can be either an extension number, an operator console or a fictive number. Please ask your system administrator if you require this function.

Note: *The number of cordless extensions in a hunt group are limited to eight (including Tandem configurations).*

Incoming calls to the hunt group are directed to free extensions in the group. The hunt order within the group can be changed to suit your needs. If all members of the hunt group are busy, an incoming call is being queued. If no one answers this call before the programmed time, the call is forwarded to the programmed answering position (e.g. operator).

Note: *If all members in a hunt group are busy, the Callback or Intrusion function is not available.*

Log in

Before you can answer Group Hunting calls, you must log in.

To log into one hunt group:

✳ 28 ✳

Dial.



Dial the hunt group code.

Please ask your system administrator for the configured number.

#

Press.

To log into all hunt groups:

*** 2 8 *** Dial.
*** #** Press.

Answer calls

Answer Group Hunting calls in the normal way.

Log out

To log out from one hunt group:

2 8 * Dial.



Dial the hunt group code.

Please ask your system administrator for the configured number.

Press.

To log out from all hunt groups:

2 8 * Dial.

*** #** Press.

Other Useful Features

By using these features your productivity will be increased, e.g. you can set reminders for important meetings, place the cost for external calls on separate accounts, listen to music via the loudspeaker and much more ...

Tandem configuration

The Tandem configuration is a unit, consisting of two telephones using the same directory number. One of the telephones is defined as the Primary and the other one as the Secondary.

This function enhances the communication for users that, for example, have a wired phone on their desk (the primary telephone) and need to be mobile within their company's building with their own portable (the secondary telephone). Basically the Tandem configuration works as follows:

To activate the Tandem configuration

Secondary on/off



***28#**

Press (pre-programmed).

Or:

Dial to log on the secondary telephone.

For incoming calls:

- Both telephones are treated as 1 single extension.

For outgoing calls:

- Both telephones are treated as 2 separate extensions.

Secondary on/off



2 8

To deactivate the Tandem configuration

Press (pre-programmed).

Or:

Dial to log off the secondary telephone.

For incoming calls:

- The secondary telephone cannot be called and the primary telephone works as a normal stand-alone telephone.

For outgoing calls:

- Both telephones are treated as 2 separate extensions.

Inquiry



Transfer



Transferring a call between members of a Tandem unit

Press and dial own directory number.

Press (pre-programmed).

Or:

Go on-hook.

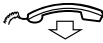

Reminder

The phone can be set to remind you at any time within the next 24 hours (multiple settings are allowed).

✳ 3 2 ✳

⊙ ⊙ ⊙
⊙ ⊙ ⊙ #
⊙ ⊙ ⊙
⊙

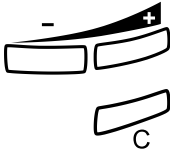

Dial.

Dial reminder time and press.

(00-23) hour + (00-59) minute. Example: 1430.

Note: *If you receive busy tone, your extension does not have the authority to set a reminder.*

In case of a typing error, press the Volume Down key to delete the latest entered digit.

Press to finish programming.

When the reminder time is reached, your phone rings with recall signal.

Cancel reminder

3 2



Dial to cancel all settings.

Press to finish the procedure.

Background Music

You can listen to Background Music over the loudspeaker on your phone by pressing a pre-programmed Music key, or by entering the number for the music channel. Please ask your system administrator for the configured number.

Background Music



Press to activate the music (pre-programmed).

The music automatically switches off when you make or receive calls and switches on again when the call is finished.

Press to cancel the music.

Note: You can adjust the volume, see section [“Settings”](#) on page 82.

Doorphone

The Doorphone is used to monitor the admission to your company, i.e. you can open the doorlock from your phone.



Answering Doorphone calls

Lift the handset.

You will be in speech connection with the calling party.

Opening of the doorlock

After you have answered the Doorphone, you can open the door making an inquiry to the door-opener’s directory number.

Inquiry



Press.

Dial the door-opener’s directory number.

Please ask your system administrator for the number.

Note: You can also program the door-opener’s directory number as a Common Abbreviated Number or a function key.

Intercom Line

A two-way direct call function between two extensions, for instance in executive-secretary communication.

*Intercom
secretary*

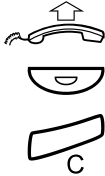

Lift the handset.

Press to establish an Intercom call (pre-programmed).

Press to cancel the Intercom call.

Night Switching

If you want this feature, please ask your system administrator. This function is used for directing all incoming calls to one extension (answering position), e.g. when the office is closed.

Night



Press to activate or deactivate (pre-programmed).

When the lamp lights, Night Switch is active. When the lights extinguishes, Night Switch is passive.

Direct Inward System Access (DISA)

If you are working externally and you have the need to make business calls, call your company and use the company PBX to make an external call to the desired party. You just pay the cost for the phone call to your company. The other cost will automatically be placed on your extension number or on a special project.

Note: To activate this function, you have to change the Default Password from 0000 to a personal one. Which code to use and how to change it, see section [“Change Password”](#) on page 64.

You can also divert calls from your office extension to your external position, see section [“Call Forwarding”](#) on page 37. During the procedure you will be prompted for your Password.



Dial the public number of your company,



followed by the DISA number.

Ask the system administrator for the defined DISA number.

Note: If want to register the call on an Account Number, you should use the Account Number procedure before you enter the external number, see section [“Account Number”](#) on page 79.



Dial the external number.

Or:

Use the External Diversion function.

Procedure, see section [“Call Forwarding”](#) on page 37.

Note: If you program a new diversion address, remember to reset it when you return to your office.

Account Number

An Account Number can be entered to debit telephone cost to different accounts. Depending on the system configuration the Account Number has to be entered from a Verified Account Number List (predefined) or you can invent your own Account Number. The following prerequisites apply:

- With the Verified Account Number you can restrict the making of external calls (not a specific number or area), so everyone who is allowed to make external calls will receive an Account Number which has to be used each time he/she wants to make an external call.
- Verified Account Numbers contain up to 10 digits and can only be used *before* you make a call (outgoing external calls).
- Own Account Numbers contain up to 15 digits and can be used *before* or *during* the call (outgoing external calls).
- The Account Numbers can also be used via the DISA function, see section “[Direct Inward System Access \(DISA\)](#)” on page 78.

Verified or own Account Number



Lift the handset.

*** 9 ***

Dial.

This code cannot be entered during the call.

Or:



Press (pre-programmed).



Enter Account Number and press.

Valid digits 0-9.

*Account
number*

DTMF Tones

The DTMF function is used to control answering machines or any other telecommunication devices.

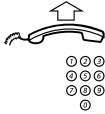

Lift the handset.

Make an internal or external call to reach the desired device.

When your call is answered you can continue to dial digits which will be sent as DTMF digits (tone signals) to the called device in order to activate the desired functions.

Networking

Networking is the connection of several premises within a company. The connection can be set up via leased lines, public lines, Local Area Network (LAN) or Wide Area Network (WAN). Ask your system administrator about details regarding networking.

IP Calls

IP Calls are internal calls sent via an internal data network (LAN or WAN) and the transfer of data and voice is made on the same line. If you are connected to an internal data network the IP connection is made automatically. To minimize the traffic on the network the speech quality is decreased.

If the speech quality is not acceptable you can disconnect the IP call and switch to a non-IP call (alternative network). The switch from the IP net to the non-IP net is made during the call, so the call does not have to be disconnected. If you want to switch to a non-IP net during the call:

Inquiry 

*** 6 1 ***

Press.

Dial.

During the procedure the other party is put on hold. When the procedure is ready you will receive a special ringing tone and the call is resumed in the non-IP net.

Note: A switch to a non-IP call can only be performed if the original call is an IP call, otherwise you will receive a Blocking tone.

Least Cost Routing

Least Cost Routing (LCR) automatically selects the cheapest way to establish the connection to the desired external number. Please ask your system administrator if this function is installed in your system. If the extension has been configured to use LCR, each external call will be analysed and the cheapest routing will be selected.



Use Least Cost Routing

Lift the handset.



0



Dial the digit(s) for external call access and the external number.

The usual way of making an outgoing external call.

Calling Least Cost Routing

If LCR has been installed in your system, but your extension is not configured to use it automatically, you also have the opportunity to get the cheapest connection by dialling the LCR code before you dial an external number.



Lift the handset.



Dial the LCR code.

Please ask your system administrator for the LCR code.

0



Dial the digit(s) for external call access and the external number.

Note: *You can also program the LCR code on a function key.*

Settings

If you require frequent use of certain functions, you may program them on the programmable keys on the telephone. When you want to use the function, just press the key.

Notes: *Programming of Dial-by-Name keys and Individual Abbreviated Numbers are described in section “[Outgoing Calls](#)” on page 17 and how to program a new diversion address is described in section “[Call Forwarding](#)” on page 37.*

Program a function

How to program a function on a programmable key.

Note: *Some functions can also be programmed as Individual Abbreviated Numbers, see section “[Outgoing Calls](#)” on page 17.*

00



Enter Programming mode.

Press the desired programmable key.

Select Function code.

See section “[Function codes and required data](#)” on page 84.

Press the programmable key again.

Enter associated number.

See section “[Function codes and required data](#)” on page 84.



Press the programmable key again.

Continue with section [Select Ringing Character](#).

Or:



Press to finish programming.

After approximately 10 seconds, the Function key is active.

Select ringing character



Select ringing character (0-4).

See section "[Function codes and required data](#)" on page 84.



Press the programmable key again.



Press to finish programming.

After approximately 10 seconds, the Function key is active.

Example:

Program Supervision of extension 204 on a programmable key, with ringing character 1. For available Function codes, see section "[Function codes and required data](#)" on page 84.

00

Enter Programming mode.



Press the desired programmable key.

13

Select the Function code for Supervision.



Press the programmable key again.

204

Enter extension number.



Press the programmable key again.

1

Press to select ringing character.



Press the programmable key again.



Press to finish programming.

Function codes and required data

Programming name	Function name	Function code	Associated number	Ringing character
NAMECALL	Dial-by-Name	10	Extension number	—
SUFFIX DIGIT	Camp-on	11	4	—
	Automatic Callback	11	5	—
	Answer calls, another extension	11	6	—
	Radio Paging	11	7	—
	Intrusion	11	8	—
EXTERNAL LINE	External Line	12	Directory number of line	0 – 4
SUPERVISION	Supervision/Tel. Attendance	13	Extension number	0 – 4
DEDIC. LINE	Intercom Line	14	Extension number	0 – 4
BUSY LINE 2	Free On 2nd Access	26	—	—
CONFERENCE	Conference	27	—	—
IMMED. ANSWER	Immediate Answer	28	—	—
EXT. VOICE M.	External Voice Mail	34	—	—
HOLD	Hold	35	—	—
TRANSFER	Transfer	36	—	—
SAVE	Save/Redial	37	—	—
NUMB SECRECY	Number Secrecy	40	—	—
ARD REQUEST	Automatic Redial	46	—	—
ARD PAUSE	Pause Automatic Redial	47	—	—

Note: Accessible functions depend on the programming of the system; if you require another function please contact your system administrator. The functions above are the default functions.

Ringing character:

0 = No ringing.

1 = Ringing.

2 = Delayed ringing (after 10 seconds).

3 = One single ringing signal (muted signal).

4 = One delayed ringing signal (after 10 seconds. Muted signal).

Alternative programming for Automatic Callback, Camp-on, Intrusion

The associated number for using the Automatic Callback, Camp-on or the Intrusion function may vary from country to country. If you cannot use a code of a function, maybe your exchange system has been programmed with a different associated number.

Because this User Guide describes only the default programming, the following table shows the most common settings in some of these countries that are known for a different programming.

	<i>Austria, Belgium, Brazil, Denmark, Germany</i>
<i>Camp-on</i>	5
<i>Automatic Callback</i>	6
<i>Answer calls, another extension</i>	8
<i>Intrusion</i>	4

Handset and loudspeaker volume

Use the volume keys. You can set different volume levels for internal and external calls and for Background Music. During a call, adjust handset listening volume in handset mode. Adjust loudspeaker volume in Monitor mode or during Background Music.



General:

Press to change the volume.

Loudspeaker volume during Group Listening

Note: Dialog 4220 Lite only.

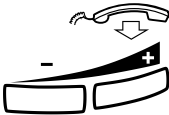

Replace the handset.

Press to change the volume.

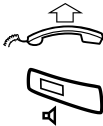

Lift the handset.

Press the Loudspeaker key.

Ringling signal

By programming, you can adjust ringing type (2 types), ringing volume (10 steps) and ringing character (10 characters).

*** 0 0 ***

Enter Programming mode.

You can now select ringing type, volume or character.

Ringling type

Select type 1 if you want to set the ringing volume at a constant level, select type 2 if you want gradually increasing volume when the phone rings.

1 * 1

Press.

Or:

1 * 2

Press.

You will hear the selected type.



Press to finish the procedure.

Note: When type 2 is selected, the programming of the ringing volume is not applicable.

Ringling volume

2 * 0 - 9

Press.

You will hear the selected volume (0...lowest volume, 9...highest). You only have to press the last digit to select another ringing volume.



Press to finish the procedure.

Note: This programming is not applicable when you have selected ringing type 2.

Ringling character

3 * 0 - 9

Press.

You will hear the selected character. You only have to press the last digit to select another ringing character.



Press to finish the procedure.

Accessories

This chapter describes optional features that can be used together with your BusinessPhone telephone.

Alarm interface unit

Note: *Only available for the Dialog 3210.*

This plug-in module is fitted into the bottom of the telephone. It makes it possible to transfer alarm signals from various devices via the telephone to the exchange and to a pre-defined extension. A special circuit layout provides maximum functional security.

To a telephone fitted with an alarm interface unit you can connect devices such as bathroom alarms for hotel rooms, emergency alarms for hospitals, bank security alarms and supervision of machines.

Option unit

Dialog 4220 Lite

The Option unit DBY 420 02 is an optional accessory, to be installed on the bottom of your telephone set. The following devices can be installed via the Option unit:

- Tape recorder
- Extra bell or busy indication outside your door
- USB connector

Dialog 3210

The Option unit DBY 410 02 is an optional accessory, to be installed on the bottom of your telephone set. The following devices can be installed via the Option unit:

- Tape recorder
- Extra bell or busy indication outside your door
- Enhanced Headset functionality
- PC Sound Card
- Second handset

Note: *For people with impaired hearing the Option unit offers the possibility to amplify the receiving volume in the handset and headset.*

Extra handset

Note: *Only available for the Dialog 3210.*

Useful for involving a second person in your conversation, for talking or just listening.

Tape recorder

When a recording of the telephone conversation is needed, for evidence purposes, a tape recorder can be connected.

Headset

Note: The Headset function is only available for the Dialog 3210 Basic equipped with option unit DBY 410 02. How to install the option unit, see separate installation instructions provided with the option unit.

The following Headset functions are available.

Activate/Deactivate the headset



Press the Headset key to activate/deactivate.

See section “[Dialog 3210 Basic](#)” on page 8. All calls can be handled via the headset.

Answer calls



Press the flashing Line key to answer.



Press to terminate a Headset call.

Make calls

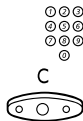

Dial the number.

Press to terminate the call.

Headset to handset



Lift the handset.

Handset to headset



Press the Headset key (pre-programmed).

Useful Hints

Connections between external lines

With your BusinessPhone PBX, you can establish an external call diversion or a conference with more than one external party or transfer an external call to another external destination (e.g. a mobile phone). These features are very useful for everyday business life.

Note: *When these features are used, your BusinessPhone will occupy at least two external lines.*

However, there may be disadvantages in connecting to several external lines. We would therefore like to draw your attention to the following:

- **Please do not transfer external calls to an external Mailbox, to information systems or to external parties before they have answered.**
- **Cancel your calls by pressing the Clear key.**

If the external parties are not persons (Mailbox, automated information or attendant systems, etc.), connections on external lines can last a long time, which can be costly. Moreover, such calls may occupy two of your system's external lines. You can restrict connections between the external lines by re-programming your system.

Please ask your system administrator or contact our service center for more information.

Installation

Dialog 4220 Lite

Install cables

You can put the cable to the handset in the notch underneath the telephone. The cable to the exchange has to be plugged in LINE and the handset cable has to be plugged in HANDSET.

Change cables

Use a screwdriver to unlock the stop.

Install stands and adapt telephone

Position high

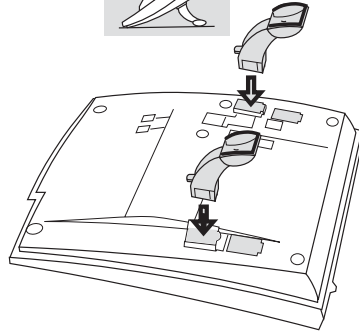

Position low

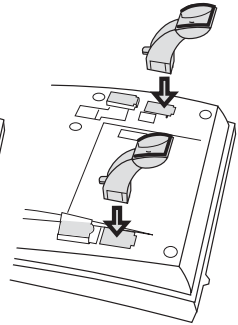
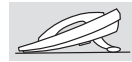

Press to fasten stand

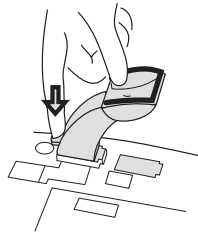

Release to remove stand

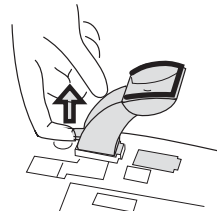

Install pullout leaf

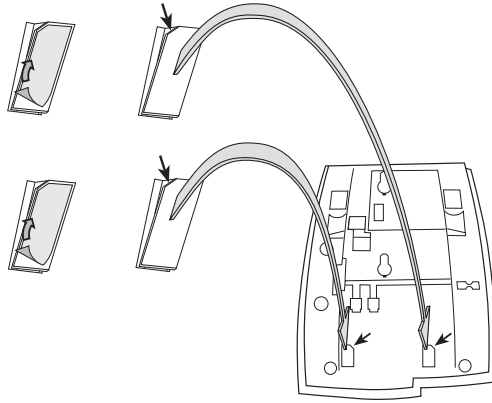

- 1 Remove the protective film from the guiding rails.**
- 2 Attach the guiding rails to the bottom of the phone, observing the direction of the “cut” corner.**

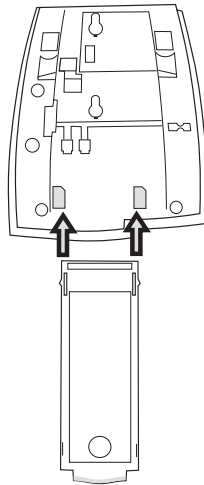

- 3 Insert the pullout leaf.**

Wall mounting handset hook

The phone can be wall mounted without using a special console. Useful for instance in conference rooms or public areas.

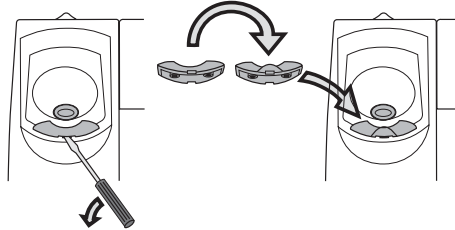

- 1 Use a screwdriver to remove the handset hook.**
- 2 Turn the hook upside down and insert.**

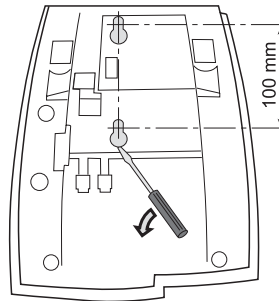

- 3 Use a screwdriver to remove the two plastic covers.**
- 4 Drill wall holes according to measure.**

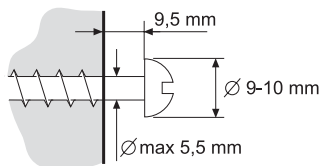

- 5 Mount screws according to measures and attach the phone.**

Install card

Use the Designation Card Manager to make and print your own designation cards. The Designation Card Manager is included on the Ericsson Telephone Toolbox CD. For questions regarding the product, please contact your Ericsson Enterprise Certified Sales Partner.

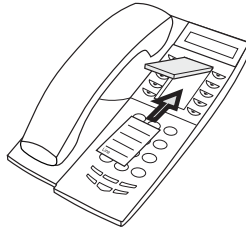

Placing the phone

- Do not place your telephone on sensitive surfaces. Use a non-slippery pad to protect your furniture from possible damage.
- Do not place your telephone near sources of extreme heat, e.g. near the radiator.
- Make sure that the line cable isn't creased.

Cleaning the telephone

Use a slightly moistened (not wet) soft cloth or an anti-static cloth and wipe off the telephone carefully. Do not use rough cloth, solvents or aggressive cleaning fluids. Any damages of the telephone, that are caused by non-observance of these instructions, are not part of the liability given by the manufacturer.

Dialog 3210 Basic

Install cables

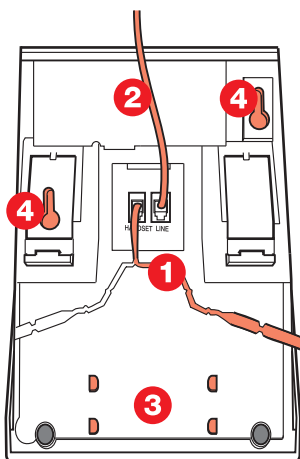

- 1 Cable to handset
- 2 Cable to exchange
- 3 Space for personal directory list (optional)
- 4 Wall mounting screw holes

You can put the cable to the handset in any of the two notches underneath the telephone. The cable to the exchange has to be plugged in LINE.

Change cables

To remove a cable, push down the plug stop. Use a screwdriver to unlock the stop.

Wall mounting handset hook

When mounting on a wall, you have to pull out and turn the hook.

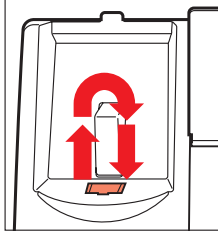

Install stand and adjust telephone

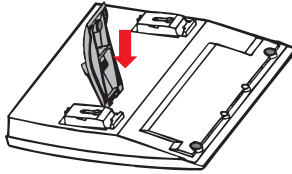

Press to decrease angle

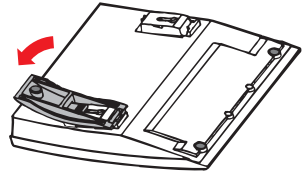

Pull to increase angle

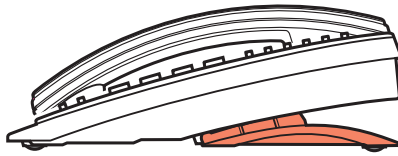
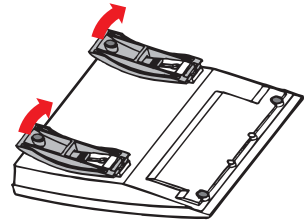
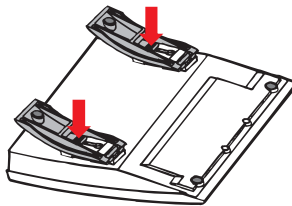

Adjustable angle

Placing the telephone

- Do not place your telephone on sensitive surfaces. Use a non-slippery pad to protect your furniture from possible damage.
 - Do not place your telephone near sources of extreme heat, e.g. near the radiator.
 - Make sure that the line cable isn't creased.
-

Cleaning the telephone

Use a slightly moistened (not wet) soft cloth or an anti-static cloth and wipe off the telephone carefully. Do not use rough cloth, solvents or aggressive cleaning fluids. Any damages of the telephone, that are caused by non-observance of these instructions, are not part of the liability given by the manufacturer.

Glossary

Abbreviated Number Dialling

Initiating a call to a pre-programmed number by dialling a code or pressing a key. Short numbers can be:

1. *Common, which means that all extensions can use them.*
2. *Individual, which means that they are programmed and used by each extension separately (10 numbers).*

See section “[Outgoing Calls](#)” on page 17.

Account Number

To place call cost on an Account Number. See section “[Other Useful Features](#)” on page 73.

Automated Attendant

A facility which sends voice instructions to internal and external callers, providing all options which can be chosen. Voice instructions lead the caller to the desired destination.

See section “[Other Useful Features](#)” on page 73.

Callback

An indication to a busy extension, to inform the person that you want to speak to him/her. See sections [Internal messages](#) and “[Outgoing Calls](#)” on page 17.

Camp-on

To place (queue) a call to a busy extension. See section “[Outgoing Calls](#)” on page 17.

Dial-by-Name

Initiation of a call by operating a single key. Internal numbers (or Common Abbreviated Numbers) can be stored on each extension. See section “[Outgoing Calls](#)” on page 17.

Direct Inward System Access (DISA)

If you are working externally, the DISA function enables you to make external calls (long distance) via the company PBX. You only pay for the call to your company. See section “[Outgoing Calls](#)” on page 17.

Directory number

Numbers with 1 – 8 digits which are assigned to extensions or external lines or as Common Abbreviated Numbers.

Diversion

Incoming calls to an extension are diverted to another directory number (extension, Common Abbreviated Number or the operator).

There are three possibilities:

1. *Direct, which means that all calls to an extension are forwarded directly.*
2. *On no reply, which means that a call is forwarded if it is not answered within a certain time.*
3. *On busy, which means that a call is forwarded if the extension is busy.*

See section “[Call Forwarding](#)” on page 37.

Diversion Bypass

This is useful for letting urgent calls through to an extension where diversion is active. See section “[Call Forwarding](#)” on page 37.

Extension

All telephones connected to the PBX have a unique internal number (up to 8 digits).

Function code

A digit code that corresponds to a specific function.

See section “[Settings](#)” on page 82.

Hold

To put a call on hold.

See section “[During Calls](#)” on page 28.

Information

Internal callers are informed about absence and time of return. External callers are diverted to the operator, where the same information is available. Information can be of two kinds:

1. *Pre-programmed text information.*
2. *Voice information.*

Intercom Line

A two-way direct call function between two extensions, for instance an executive-secretary communication.

See section “[Other Useful Features](#)” on page 73.

Intrusion

To intrude on an ongoing call when a requested extension is busy.

See section “[Outgoing Calls](#)” on page 17.

IP call

Internal call sent via an internal data network (LAN or WAN).

ISDN

Integrated Services Digital Network. Provides your system with supplementary services from the public net.

Least Cost Routing

A function that automatically selects the cheapest way to connect your external call (not necessarily the shortest distance). See section “[Least Cost Routing](#)” on page 81.

Loudspeaker Paging

All members of an extension group are paged, i.e. receive a short, sharp tone on the loudspeaker followed by a Voice message from the sender.

See section “[Group Features](#)” on page 67.

Mailbox

The Mailbox system controls the messages that are left for or sent by you when you are absent. See section “[Messages](#)” on page 51.

Message

A message can be sent to any extension. This is useful when you receive the busy tone or get no answer. There are two kinds of message:

1. *Call Me message.*
2. *Voice message.*

See section “[Messages](#)” on page 51.

Mute

To switch the microphone temporarily off. See section “[During Calls](#)” on page 28.

Night Switching

Used for directing all incoming calls to one extension (answering position), for example when the office is closed.

See section “[Other Useful Features](#)” on page 73.

Password

A four-digit code needed to e.g. block your extension and retrieve messages from the Mailbox system. You can set your own Password.

See section “[Security](#)” on page 64.

PBX

Private Branch Exchange. Your telephone switching system (e.g. BusinessPhone 250).

Pre-defined text

Pre-programmed absent information. See section “[Absence Information](#)” on page 44.

Third party

A third connection (person), which can be included in an ongoing two person conversation. The connection can be internal or external.
See section “[During Calls](#)” on page 28.

Tie line

An external line from the private network.

Transfer

During an internal or external ongoing call you can make an inquiry and then transfer the call to another party (internal or external). See sections “[During Calls](#)” on page 28 and “[Useful Hints](#)” on page 91.

Trunk line

A trunk line is the same as an external line. Can be either digital or analog.

Index

A

- Abbreviated Numbers 23
 - Common 24
 - Individual 26
- Absence Information 44
 - Change information 47, 50
 - Enter information 45, 48
 - Erase 50
- Accessories 88
- Account Number 79
- Alarm interface unit 88
- Alternative programming for Automatic
Callback, Camp-on, Intrusion 85
- Answer calls 14
- Automatic Callback 19
- Automatic Redial 20

B

- Background Music 76
- Block extension 66
- Busy extension 22
- Bypass blocked extension 65
- Bypass Call Forwarding 23

C

- Call Forwarding 37
 - Diversion when caller receives busy tone 37
 - Diversion when there is no answer 37
 - Fixed Diversion 38
 - Follow-me 43
 - Individual Diversion 40
 - Program Fixed Diversion address 39
- Call Waiting 33
- Change information 47, 50
- Change Password 64
- Check and store received messages 56
- Common Abbreviated Numbers 24
- Common Bell 70
- Common Hold 36

- Common Mailbox system 58
- Conference 34
- Connections between external lines 91
- Conversation Recording 63

D

- Description 6
 - Lamp indications 10
 - Signals 13
 - Tones 12
- Dial-by-Name 27
- Dictaphone 62
- Dictaphone function 62
- Direct Inward System Access (DISA) 78
- Diversion when caller receives busy tone 37
- Diversion when there is no answer 37
- Diverted extension 23
- Doorphone 76
- DTMF Tones 80
- During Calls 28
 - Call Waiting 33
 - Conference 34
 - Group Listening 28
 - Inquiry 30
 - Mute 29
 - Park call 36
 - Refer Back 31
 - Transfer 32

E

- Enter information 45, 48
- Erase information 50
- Extra handset 89

F

- Fixed Diversion 38
- Follow-me 43
- Forward a Voice message 57

Function codes and required data 84

G

- Glossary 100
- Group Call-pick-up 69
- Group Features 67
 - Common Bell 70
 - Key system 67
 - Pick-up group 69
 - Supervision 68
- Group Hunting 71
- Group Listening 28

H

- Handset and loudspeaker volume 86
- Headset 90
- Hold 36

I

- Incoming Calls 14
 - Answer calls 14
 - Silent ringing 15
- Individual Abbreviated Numbers 26
- Individual Abbreviated Numbers via a programmable key 24
- Individual Diversion 40
- Individual Hold 35
- Individual Mailbox system 52
 - Information
 - Erase 50
- Inquiry 30
- Installation Dialog 3210 97
 - Adjust 98
 - Cables 97
 - Cleaning 99
 - Placing 99
 - Stands 98
 - Wall mounting handset hook 98
- Installation Dialog 4220 92
 - Adapt 93
 - Cables 92
 - Card 96
 - Cleaning 96
 - Placing 96
 - Stands 93
 - Wall mounting handset hook 95
- Intercom Line 77
- Internal Messages 51
- IP Calls 80

K

- Key system 67

L

- Lamp indications 10
- Last External Number Redial 18
- Least Cost Routing 81
- Loudspeaker Paging 69

M

- Mailbox system
 - Common 58
 - Individual 52
- Make calls 17
- Messages 51
 - Check and store received messages 56
 - Common Mailbox system 58
 - Conversation Recording 63
 - Dictaphone 62
 - Forward a Voice message 57
 - Individual Mailbox system 52
 - Outcall (External) Notification 55
 - Password protection 51
 - Personal Greeting 53
 - Send 61
- Monitoring 29
- Music 76
- Mute 29

N

- Networking 80
- Night Switching 77

O

- Option unit 88
- Other Useful Features 73
 - Account Number 79
 - Background Music 76
 - Direct Inward System Access (DISA) 78
 - Intercom Line 77
 - IP Calls 80
 - Least Cost Routing 81
 - Networking 80
 - Night Switching 77
 - Reminder 75
 - Tandem configuration 73
- Outcall (External) Notification 55
- Outgoing Calls 17
 - Automatic Redial 20
 - Callback 19

- Common Abbreviated Numbers 24
- Dial-by-Name 27
- Diverted extension 23
- Individual Abbreviated Numbers 26
- Individual Abbreviated Numbers via a programmable key 24
- Make calls 17

P

- Password 64
- Password protection 51
- Personal Greeting 53
- Pre-defined texts 44
- Program a function 82
- Program Fixed Diversion address 39

R

- Refer Back 31
- Reminder 75
- Ringling signal 87

S

- Save and redial incoming calls 16
- Save external number 18
- Save information 50
- Security 64

- Send Message 61
- Settings 82
 - Function codes and required data 84
- Short Numbers 23
- Signals 13
- Silent ringing 15
- Supervision 68

T

- Tandem configuration 73
- Tape recorder 89
- Telephone Attendance 68
- Tones 12
- Transfer 32

U

- Useful Hints 91
 - Connections between external lines 91

V

- Voice information 44
- Volume 86

W





- Welcome 4

Quick Reference Guide

Answer calls

- Answer: *Lift handset*
- Answer on another extension: *Lift handset*
Ext. No. 6
- Save external number: *Please see Make calls - Save external number.*



Make calls

- Internal calls: *Lift handset Ext. No.*
- External calls: *Lift handset*
Line Access Code
External Number
- Common Abbreviated Number: *Lift handset*
Abbreviated No.
- Individual Abbreviated Number: ** * **
(Abbreviated No. 0 - 9)
- Last external number redial: ** * **
- Save external number: *2nd  Save/Redial *
(Before you finish the call)
- Redial: 2nd  Save/Redial *
- Note: For the Dialog 3210, please refer to the User Guide.*

You get busy tone or no answer

- Automatic Callback: **5** *Replace handset*
Lift handset when called back
- Camp-on: **4** *Keep handset off hook*
- Intrusion: **8**

During calls

- Group Listening:  *(Dialog 4220 Lite only)*
- Monitoring:  *(Dialog 3210 only)*
- Individual Hold: **Line** 
Press flashing key to retake



Conference

- Ongoing conversation: **Inquiry**  *Call 3rd party*
Message 



Transfer

- Transfer a call: **Inquiry**  *Call 3rd party*
Replace handset
(Before or after answer)

Inquiry

- Ongoing conversation: **Inquiry**  *or*
Line 2  *Call 3rd party*
- Note: For the Dialog 3210, please refer to the User Guide.*

Refer Back

- Switch between calls: **Line**  *or Inquiry* 
- End call: 

Messages

- Call Me: **Message**  **#**
- Voice: **Message** 
9 *Speak*
- Play-back:* *****
- Re-record:* **9** *Speak*
- Send:* **#**
- Check received: **Message** 

Call Forwarding

- Fixed Diversion: *** 2 1 #**
- Internal Diversion: *** 2 1 * New No. #**
Cancel: **# 2 1 #**
- Follow-me: *** 2 1 * Own No. ***
New No. #
Cancel: **# 2 1 * Own No. #**
- Bypass Call Forwarding: *** 6 0 * Ext. No. #**
- External Diversion:
Program: *** 2 2 * Line access code**
External No. #
Cancel: **# 2 2 #**
Re-activate: *** 2 2 * #**

Ericsson is shaping the future of Mobile and Broadband Internet communications through its continuous technology leadership. Providing innovative solutions in more than 140 countries, Ericsson is helping to create the most powerful communication companies in the world.

All rights reserved.
Ericsson Enterprise AB
For questions regarding the product,
please contact your Ericsson Enterprise Certified Sales Partner.
Also visit us on www.ericsson.com/enterprise

© Ericsson Enterprise AB 2003
EN/LZTBS 160 1320 R1A

